

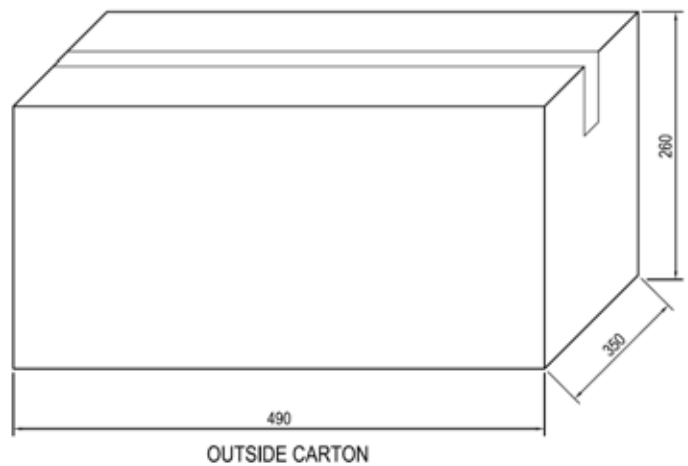

● **FOR EC/PK/WBRHID/WBRH**

Shape and size(Dimension unit: mm)

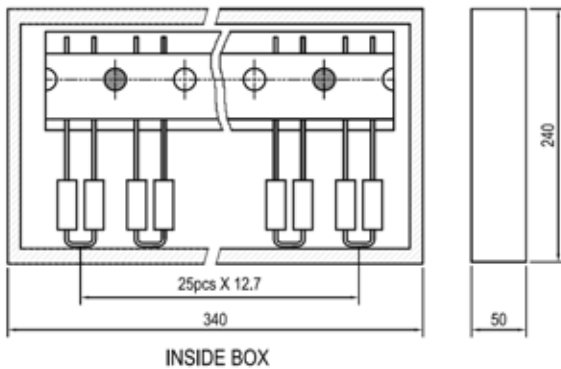
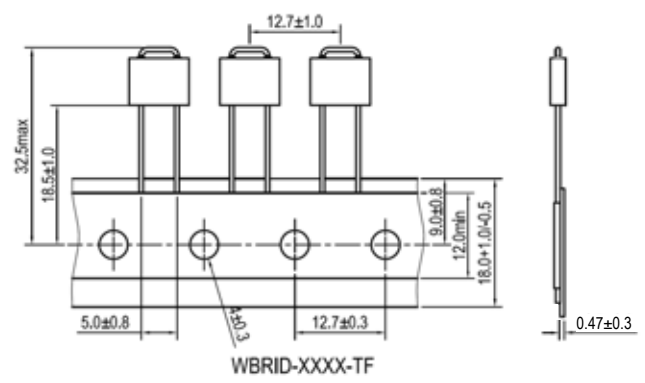
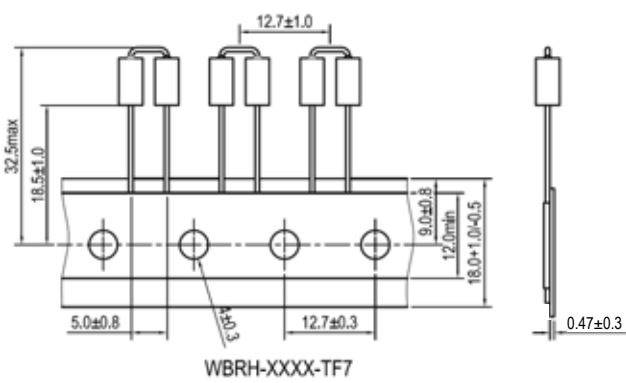
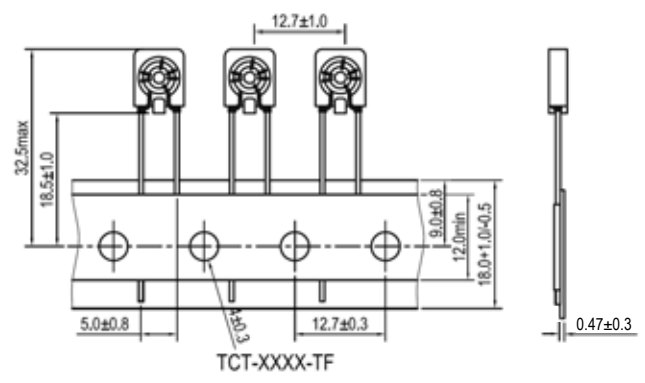
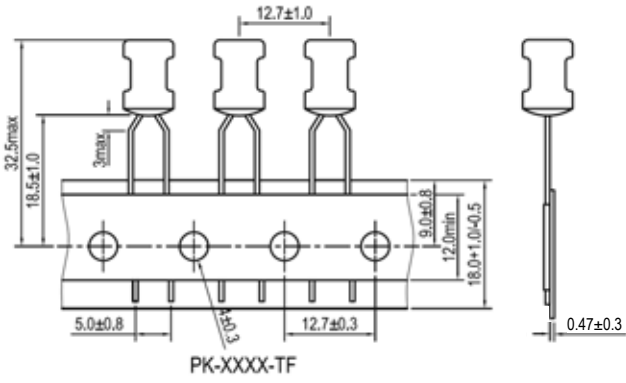
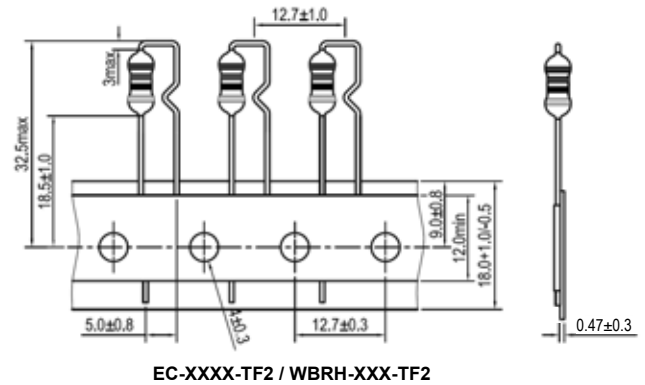
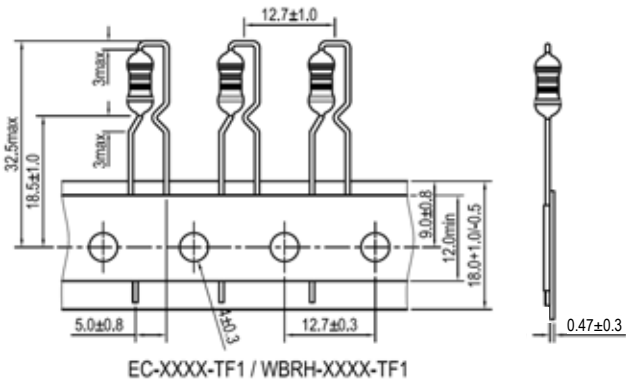

Other Specil Type



● **TAPE AND REEL SPECIFICATIONS EC/VC/MF/PK/WBRH/TCT**

Series	Type	Packaging Quantity			Carton Size ^{note2}			Gross Weight
		Parts / Box	Parts / Reel	Parts / Carton	L	W	H	
EC22	T5		5000pcs	25000pcs	330mm	330mm	460mm	9Kg
	T2A	2000pcs		72000pcs	410mm	270mm	350mm	10.5Kg
	T5A	2500pcs		62500pcs	380mm	380mm	460mm	13Kg
	TF ^{note1}	2500pcs		25000pcs	490mm	350mm	260mm	9Kg
EC24	T5		5000pcs	25000pcs	330mm	330mm	460mm	11Kg
	T2A	2000pcs		72000pcs	410mm	270mm	350mm	19.2Kg
	T5A	2000pcs		50000pcs	380mm	380mm	460mm	16.5Kg
	TF ^{note1}	2500pcs		20000pcs	490mm	350mm	260mm	10Kg
EC36	T5		5000pcs	25000pcs	380mm	380mm	460mm	16Kg
	T2A	1200pcs		43200pcs	410mm	270mm	350mm	18.3Kg
	T5A	1500pcs		24000pcs	410mm	270mm	350mm	12.4Kg
	TF ^{note1}	2000pcs		16000pcs	490mm	350mm	260mm	12Kg
EC38	T5		4000PCS	20000PCS	380mm	380mm	460mm	18Kg
	T2A	1200PCS		43200PCS	410mm	270mm	350mm	40kg
	T5A	1500PCS		24000PCS	410mm	270mm	350mm	21Kg
EC46	T5		3000pcs	15000pcs	380mm	380mm	460mm	15Kg
	T2A	800pcs		28800pcs	410mm	270mm	350mm	19.2Kg
	T5A	1000pcs		16000pcs	410mm	270mm	350mm	12Kg
	TF ^{note1}	1500pcs		12000pcs	490mm	350mm	260mm	12Kg
VC0310	T5		3000pcs	15000pcs	380mm	380mm	460mm	20Kg
	T5A	1200pcs		19200pcs	410mm	270mm	350mm	16.6Kg
VC0410	T5		3000pcs	15000pcs	380mm	380mm	460mm	18Kg
	T5A	1000pcs		16000pcs	410mm	270mm	350mm	18Kg
VC0513	T5X2		1000pcs	5000pcs	380mm	380mm	460mm	12Kg
VC0616	T5X2		1000pcs	5000pcs	380mm	380mm	460mm	13Kg
MF0616	T5X2		1000pcs	5000pcs	380mm	380mm	460mm	13Kg
MF6514	T5X2		1000pcs	5000pcs	380mm	380mm	460mm	13Kg
PK0406	TF	1000pcs		10000pcs	490mm	350mm	260mm	5.5Kg
PK0507	TF	1500pcs		12000pcs	490mm	350mm	260mm	11.6Kg
PK0608	TF	750pcs		7500pcs	490mm	350mm	260mm	7.7Kg
PK0810	TF	600pcs		4800pcs	490mm	350mm	260mm	16.7Kg
PK1012	TF	500pcs		4000pcs	490mm	350mm	260mm	18.6Kg
WBRH ^{note3}	T5		5000pcs	25000pcs	380mm	380mm	460mm	15.8Kg
	T2A	1000pcs		30000pcs	410mm	270mm	350mm	18Kg
	T5A	1500pcs		24000pcs	410mm	270mm	356mm	18Kg
	TF ^{note1}	2000pcs		20000pcs	490mm	350mm	260mm	15Kg
WBRID	TF	1800pcs		18000pcs	490mm	350mm	260mm	14.5Kg
TCT 45153	T	1500pcs		15000pcs	490mm	350mm	260mm	8Kg

NOTE 1: " TF TYPE " INCLUDES TF1, TF2.

NOTE 2: "CARTON SIZE" LISTED HERE IS "INSIDE" CARTON SIZE AND IS SAME AS FACTORY'S INTERNAL RECORD
OUTER OUTSIDE CARTON SIZE WILL BE MULTIPLIED BY 1.05 FOR VOLUME CALCULATION.

NOTE 3:WBRH-3.5X4.7X0.8,WBRH-3.5X6X0.8 AND OTHER SERIES USE THE SAME KIND OF PACKAGING BUT ARE
DIFFERENT ON WEIGHT. THE TABLE ABOVE SHOWS THE WEIGHT OF WBRH-3.5X4.7X0.8 ONLY.

● IN BAG PAKEAGE

Series			23×29	181207	261916	412718
	膠袋	每袋	每板	小箱	內箱	外箱
EC22	8×6	1000		5000	35000	70000
EC23	8×6	1000		5000	30000	60000
EC24	8×6	1000		5000	30000	60000
EC36	8×6	1000		5000	20000	40000
EC38	8×6	1000		5000	20000	40000
EC46	8×6	500		3000	12500	25000
EC0410	8×6	500		3000	12500	25000
VC0310	7×5	500		2000	8000	16000
VC0410	8×6	500		2000	8000	16000
VC0513	7×5	250		1000	4000	8000
VC1019	7×5	50		200	800	1600
MF0616	8×6	150		450	1800	3600
MF6514	7×5	150		600	2400	4800
PK0406	4×6	500		2500	10000	20000
PK0608	4×6	200		1000	4000	8000
PK0707	4×6	200		1000	4000	8000
PK0807	4×6	100		500	2000	4000
PK0810	4×6	100		500	2000	4000
PKS0605	4×6	250		1000	6000	12000
PKS0605			800		4800	9600
PKS0606			900		5400	10800
PKS0805			500		2500	5000
PKS0807			500		2500	5000
PKS0809			500		2500	5000
PKS4W1006			350		2450	4900
PKS4W1008			390		2340	4680
PKS4W1010			350		2100	4200
PKS1014			330		1320	2640
PKB0804	4×6	200		1000	4000	8000
PKB0865	4×6	100		500	2000	4000
PKB0809	4×6	100		500	2000	4000
PKB0809			450		1800	3600
DR0606	4x6	200		1000	2000	4000
DR0707	4x6	100		1000	2000	4000
DR0807	4x6	100		1000	2000	4000
DR1010			230		1380	2760
MF0709	4×6	100		500	2000	4000
MF0809	4×6	100		500	2000	4000
MF1112	4×6	100		400	1600	3200
FS0606	4×6	500		2500	10000	20000
FS0807	4×6	100		500	2000	4000
FS0807			500		3000	6000
FS4W1010			400		2000	4000



● **IN BAG PAKEAGE**

Series			23×29	181207	261916	412718
	膠袋	每袋	每板	小箱	內箱	外箱
FS1012	4×6	100		300	1200	2400
FS1012			350		1400	2800
FS1215	4×6	50		200	800	1600
FS1618			100		600	1200
FSB1014	4×6	100		300	1200	2400
FSB1014			400		2000	4000
DRH1420			168		504	1008
DRH1820			108		324	648
DRH2620			30		90	180
DRH3525			30		90	180
WBRH35308	8×6	1000			16000	32000
WBRH354508	8×6	1000			16000	32000
WBRH354708	8×6	1000			16000	32000
WBRH35508	8×6	1000			16000	32000
WBRH255208	8×6	1000			16000	32000
WBRH35608	8×6	1000			16000	32000
WBRH35808	6×8	1000			16000	32000
WBRH35908	8×6	1000			15000	30000
WBRID-237573		100		500	2000	4000
WBR6H	6×8	500		1000	4000	8000
PK3W0608	4×6	200		1000	4000	8000
PK3W0810	4×6	100		500	2000	4000
PK3W0912	4×6	100		500	2000	4000
PK3W1016	4×6	50		250	1000	2000
PK3W1415	4×6	50		200	800	1600
MD-0417Y-XXT-S-X	6×8	500		1000	4000	8000
MD-0505U-XXT-C-X	6×8	1000		3000	12000	24000
MD-0507U-XXT-S-X	6×8	500		2000	8000	16000
MD-0509X-XXT-S-X	6×8	1000			12500	25000
MD-0610A-XXT-S-X	6×8	1000			10000	20000
MD-0613U-XXT-C-X	6×8	500			5000	10000
MD-0614X-XXT-C-X	6×8	500		1000	4000	8000
MD-0614U-XXT-S-X	6×8	500			5000	10000
MD-0712U-XXT-C-X	6×8	500			5000	10000
MD-0712U-XXT-S-X	6×8	500			5000	10000
MD-0712A-XXT-C-X	6×8	500		1000	4000	8000
MD-0807X-XXT-S-X	6×8	1000			10000	20000
MD-0812X-XXT-S-X	6×8	500			5000	10000
MD-0813Y-XXT-S-X	6×8	500			5000	10000
MD-1012U-XXT-C-X	8×12	500			2500	5000
MD-1012U-XXT-S-X	8×12	500			2500	5000
MD-1015U-XXT-S-X	8×12	500			2500	5000
MD-1015X-XXT-S-X	8×12	500		500	2000	4000
MD-1018U-XXT-C-X	8×12	500			2000	4000
MD-1018U-XXT-S-X	6×8	500			2000	4000



● **IN BAG PAKEAGE**

Series			23×29	181207	261916	412718
	膠袋	每袋	每板	小箱	內箱	外箱
MD-1213X-XXT-S-X	6×8	500	K7BOX/200 K10BOX/100 K10BOX/80	1000	4000	8000
MD-0505S-XXT-C	6×8	500		2000	8000	16000
MD-0507S-XXT-S	6×8	500		2000	8000	16000
MD-0712S-XXT-C/S				2000	2000	4000
MD-1012S-XXT-C/S				2000	2000	4000
MD-1015S-XXT-S				1600	1600	3200
MD-1018S-XXT-C/S	6×8	500		2000	2000	4000
MD-0707Y-2.5T	6×8	1000		2000	8000	16000
MD-0707Y-4.5T	6×8	1000		2000	8000	16000
MD-0707Y-5.5T	6×8	1000		2000	8000	16000
MD-0707Y-7.5T	6×8	1000		2000	8000	16000
MD-0707Y-8.5T	6×8	1000		2000	8000	16000
MD-0707Y-14.5T	6×8	1000		4000	8000	16000
TR-02	8×6	500		1000	4000	8000
TR-03	7×5	500		1500	6000	12000
TC(2026)	4×6	500		3000	12500	25000
TC(3026)	4×6	200		2000	8000	16000
TC(3726)	4×6	100		500	2000	4000
TC(4426)	4×6	100		500	2000	4000
TC(5026)	6×8	100		500	2000	4000
TC(6026)	6×8	100		300	1200	2400
TC(6826)	6×8	100		200	800	1600
TC(8026)			100		500	1000
TC(9026)			120		480	960
TC(9426)			100		400	800
TC(10626)			36		216	432
TC(13026)			24		168	336
TC(3018)			400		2400	4800
TC(3818)			250		1500	3000
TC(4453)			280		1680	3360
TC(5018)			120		600	1200
TC(5052B)	4×6	100		500	2000	4000
TC(5053B)			200		1200	2400
TC(6018-F)			130		780	1560
TC(6053)			180		1080	2160
TC(6018)			160		960	1920
TC(6052-F)			140		700	1400
TBV(6826)			54		270	540
TBV(4426)			400		1600	3200
TBV(6026)			100		200	400
TBC			140		540	1080
TBKM(4426)			300		1500	3000
TBKM(6826A)			70		350	700
TBKM(8026B)			100		400	800
TBKM(10626)			100		400	800



● **IN BAG PAKEAGE**

Series			23×29	181207	261916	412718
	膠袋	每袋	每板	小箱	內箱	外箱
TBH(9026)			42		210	420
TBH(3726)			350		2100	4200
TBH(4426)			230		1610	3220
TBH(6026)			165		660	1320
FC0205	4×6	1000		2000	8000	16000
FC0310	4×6	25		100	400	800
FC0415	4×6	200		1000	4000	8000
FC0520	4×6	100		500	2000	4000
FC0630	6×8	100		200	800	1600
TCT(45153)	6×8	1000		2000	8000	16000
LFD648075			800		4000	8000
LFD707010			520		3640	7280
LFV129	6×8	100		200	800	412735/3200
LFV	8×12	100		100	400	412735/1600
LFV2208			40		240	480
LFV2513			48		240	480
LFV3715			24		120	240
LFT1206	4×6	100	40	500	2000	4000
LFT1608			80		480	960
LFT2208			50		350	700
LFT2513			32		192	384
LFT3113			48		240	480
LFTB1206			195		780	1560
LFTB3113			24		120	240
LFH			75		375	412735/1500
LFC			80		240	412735/960
LFH			48		240	480
LFLV			32		192	384
LFTH2208			48		240	480
LFU9.8			240		1200	2400
LFU9.8H			165		825	1650
LFU10			140		560	1120
LFU16			100		400	800
LFUT20			120		480	960
ET24			95		285	570
ET28			60		180	360
BLRID2×2.5×3.5	4×6	1000		6000	24000	48000
BLRID3×3×5	4×6	250		1250	5000	10000
BLRID7×7.5×13.4	4×6	100		500	2000	4000
BLRHH6×4	4×6	500		1500	6000	12000
BLRHH7×5.5	8×6	500		1500	6000	12000

181207(小小盒)四個裝入一個 261916 紙箱;二個 261916 裝入一個 412718 紙箱,而 412735 紙箱可以裝四個 261916 紙箱。



● **TAPE AND REEL SPECIFICATIONS**

Shape and size : (Dimensions are in mm)

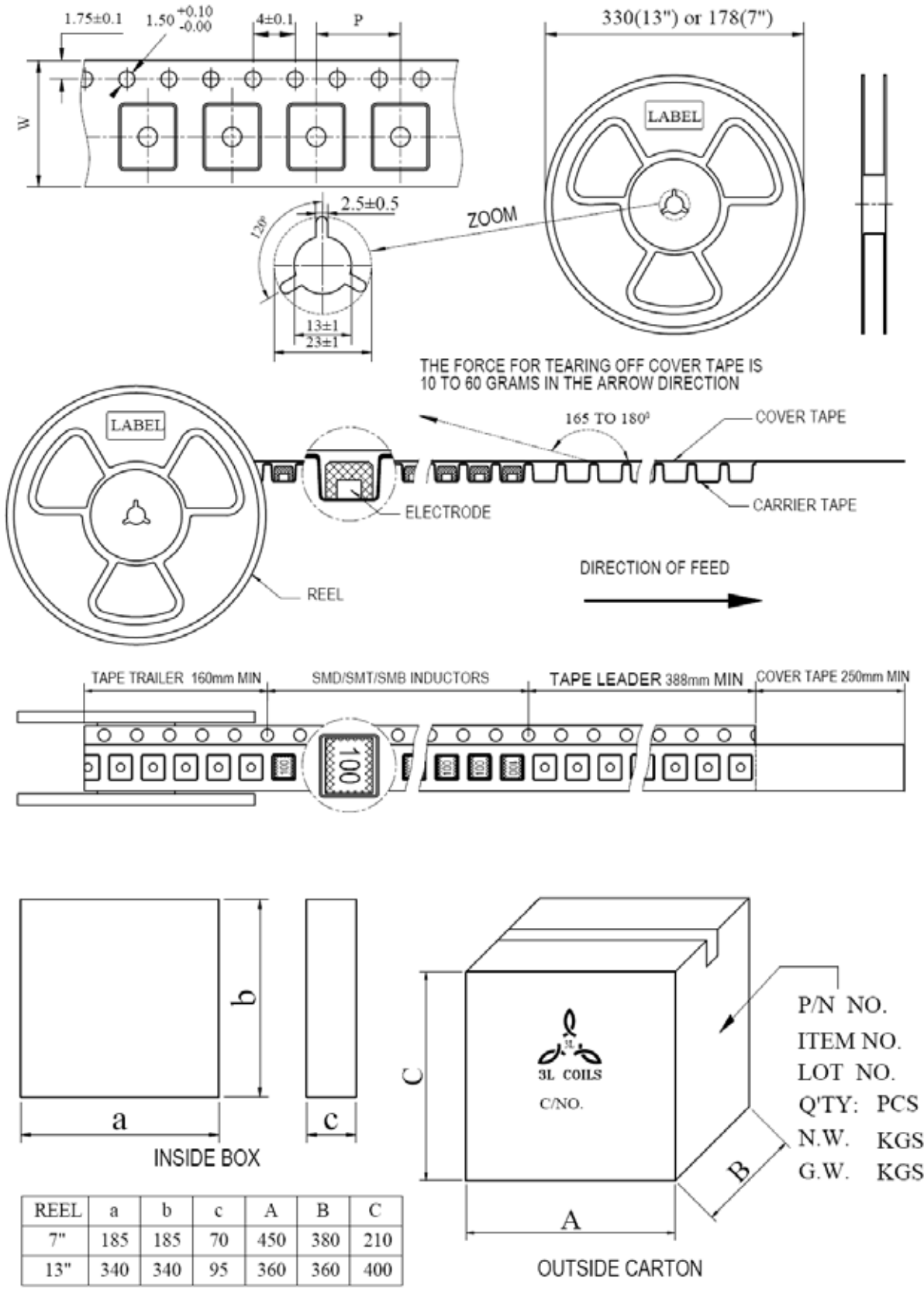



Series	Tape size		Parts Per Reel			Per Box		Per Carton	
	W	P	7"	13"	G.W	N(卷數)	Q'ty	Q'ty	G.W
BDE2D10	12	8		4000	520g	5	20k	80k	15.8kg
BDE2D12	12	8		4000	667g	5	20k	80k	18.7kg
BDE2D15	12	8		4000	720g	5	20k	80k	19.8kg
BDE3D12	12	8		4000	773g	5	20k	80k	20.9kg
BDE3D15	12	8		4000	800g	5	20k	80k	21.4kg
BDE3D18	12	8		3500	723g	5	17.5k	70k	19.8kg
BDE4D12	12	8		4000	867g	5	20k	80k	22.8kg
BDE4D15	12	8		4000	933g	5	20k	80k	24.2kg
BDR2D12	12	8		4000	647g	5	20k	80k	18.3kg
BDR2D15	12	8		4000	680g	5	20k	80k	19.0kg
BDR3D12	12	8		4000	733g	5	20k	80k	20.1kg
BDR3D15	12	8		4000	760g	5	20k	80k	20.6kg
BDR3D18	12	8		3500	700g	5	17.5k	70k	19.4kg
BDR4D12	12	8		4000	827g	5	20k	80k	21.9kg
BDR4D15	12	8		4000	893g	5	20k	80k	23.3kg
BRI 2D12	12	8		4000	693g	5	20k	80k	19.3kg
BRI 2D15	12	8		4000	733g	5	20k	80k	20.1kg
BRI 2D18	12	8		3500	690g	5	20k	80k	19.0kg
BRI 3D12	12	8		4000	787g	5	20k	80k	21.1kg
BRI 3D15	12	8		4000	813g	5	20k	80k	21.7kg
BRI 3D18	12	8		3500	758g	5	17.5k	70k	19.3kg
BRI 4D12	12	8		4000	880g	5	20k	80k	23.0kg
BRI 4D15	12	8		4000	973g	5	20k	80k	24.9kg
SMD(M)2520V(P)	8	4	2000		130g	5	10k	120k	12kg
SMD(M)3225V(P/H)	8	4	2000		150g	5	10k	120k	13kg
SMD4532V(P)	12	8	500		130g	4	2k	24k	11kg
SMD5650V	16	12		1000	760g	4	4k	16k	13.5kg
SMD5650VL	16	12		1500	800g	4	6k	24k	14.8kg
SMTSDR321618C	8	4	2000		130g	5	10k	120k	12kg
SMTSDR322515	12	8	2000		152g	5	10k	120k	13kg
SMTSDR322520(C)	8	4	2000		180g	5	10k	120k	15kg
SMTSDR453226(S)	12	8	500		120g	4	2k	24k	11kg
SMTSDR453226(C)	12	8	500		140g	4	2k	24k	12kg
SMTSDR575047C	16	12		1000	780g	4	4k	16k	16kg
SMDWCM2012(H3/U)	8	4	2000		130g	5	10k	120k	12kg
SMDWCM3216	8	4	2000		170g	5	10k	120K	14kg
SMDCHGR 0402	8	2	4000		60g	5	20k	240k	7.8kg
SMDCHGR(FSR) 0603	8	4	4000		95g	5	20k	240k	10kg
SMDCHGR(FSR) 0805	8	4	3000		110g	5	15k	180k	11kg
SMDCHGR(FSR) 1008	8	4	2000		130g	5	10k	120k	12kg
SMDCHGR 1210	8	4	2000		170g	5	10k	120k	14kg
SMTSC0403	12	8		2000	430g	5	10k	40k	13kg
SMTSC0703	16	8		2000	580g	4	8k	32k	14kg
SMTSC0504	16	12		1000	520g	4	4k	16k	13kg
SMTSC1006	24	12		750	690g	3	2.25k	9k	12.3kg



Series	Tape size		Parts Per Reel			Per Box		Per Carton	
	W	P	7"	13"	G.W	N(卷數)	Q'ty	Q'ty	G.W
SMTDR31	12	8		2000	263g	5	10k	40k	7.8kg
SMTDR32	12	8		2000	530g	5	10k	40k	13kg
SMTDR43	12	8		2000	720g	5	10k	40k	18kg
SMTDR53 / 52	12	8		2000	880g	5	10k	40k	20kg
SMTDR54	12	8		1500	890g	5	7.5k	30k	22kg
SMTDR73	16	12		1000	890g	4	4k	16k	18kg
SMTDR75	16	12		1000	1.2kg	3	3k	12k	20.5kg
SMTDR104	24	12		750	1.2kg	3	2.25k	9k	18kg
SMTDR105	24	12		750	1.7kg	3	2.25k	9k	24kg
SMTDR137	24	12		400	1.8kg	2	0.8k	3.2k	17kg
SMTDR0402	16	8		2000	720g	4	8k	32k	16kg
SMTDR0802	24	16		1000	1.3kg	3	3k	12k	20kg
SMTDR0804	24	16		500	1.1kg	3	1.5k	6k	18kg
SMTDR0810	24	20		250	1.0kg	3	0.75k	3k	16kg
SMTDR1206	32	20		400	1.6kg	2	0.8k	3.2k	17kg
SMTDR0402HC	16	8		1500	850g	4	6k	24k	17kg
SMTDR0504HC	16	8		1000	800g	4	4k	16k	16.5kg
SMTDR0904HC	24	16		500	1.0kg	3	1.5k	6k	16kg
SMTDR1105HC	32	20		350	1.6kg	2	0.7k	2.8k	17kg
SMTDR1306HC	44	20		250	2.2kg	2	0.5k	2k	22kg
SMTDRH0520	12	8		2000	0.43kg	5	10k	40k	10.6kg
SMTDRH0530	12	8		2000	0.39kg	5	10k	40k	9.8kg
SMTDRH0530L	12	8		2000	0.40kg	5	10k	40k	9.9kg
SMTDRH0630	12	8		2000	0.87kg	5	10k	40k	19.4kg
SMTDRH0635	12	8		2000	0.92kg	5	10k	40k	20.4kg
SMTDRH5D28R	12	8		2000	1.1kg	5	10k	40k	25kg
SMTDRH103R	24	16		1000	1.6kg	3	3k	12k	24kg
SMTDRH104R	24	16		750	1.6kg	3	2.25k	9k	24kg
SMTDRH105R	24	16		750	1.8kg	3	2.25k	9k	26kg
SMTDRRI63B	12	8		1500	900g	5	7.5k	30k	22kg
SMTDRRI74B	16	12		1000	1.3kg	4	4k	16k	25kg
SMTDRRI105B	24	12		750	1.5kg	3	2.25k	9k	22kg
SMTDRRI125B	24	16		500	1.6kg	3	1.5k	6k	24kg
SMTDRRI74P	16	12		1000	1.2kg	4	4k	16k	24kg
SMTDRRI125P	24	16		500	1.9kg	2	1k	6k	26kg
SMTDRRI127P	24	16		350	1.8kg	2	0.7k	4.2k	26kg
SMTSDR322515(S)	12	8		500	149g	4	2k	24k	12kg
SMTSDR322520(S)	12	8		500	154g	4	2k	24k	12.5kg
SMTDRRI0402	16	8		2000	820g	4	8k	32k	17kg
SMTDRRI0804	24	16		500	1.3kg	3	1.5k	6k	20kg
SMTDRRI1206	32	20		400	1.6kg	2	0.8k	3.2k	17kg
SMTDRRI62B	16	12		1500	650g	4	6k	24k	15kg
SMTDRRI64B	16	12		1000	850g	4	4k	16k	18kg



Series	Tape size		Parts Per Reel			Per Box		Per Carton	
	W	P	7"	13"	G.W	N(卷數)	Q'ty	Q'ty	G.W
SMTDRRI73	16	12		1000	1.0kg	4	4k	16k	20kg
SMTDRRI74	16	12		1000	1.2kg	4	4k	16k	24kg
SMTDRRI124	24	16		500	1.6kg	3	1.5k	6k	24kg
SMTDRRI125	24	16		500	1.9kg	2	1k	6k	26kg
SMTDRRI127	24	16		350	1.8kg	2	0.7k	4.2k	26kg
SMTDRRI4D18	12	8		2000	540g	5	10k	40k	15kg
SMTDRRI4D28	12	8		2000	680g	5	10k	40k	18kg
SMTDRRI5D18	12	8		2000	860g	5	10k	40k	22kg
SMTDRRI5D28	12	8		2000	1.1kg	5	10k	40k	25kg
SMTDRRI6D28	16	12		1500	1.0kg	4	6k	24k	20kg
SMTDRRI6D38	16	12		1000	1.1kg	4	4k	16k	22kg
SMTDRRI8D28	24	12		1000	1.4kg	3	3k	12k	22kg
SMTDRRI8D38	16	16		750	1.2kg	3	2.25k	9k	19kg
SMTDRRI8D43	16	16		750	1.4kg	3	2.25k	9k	21.5kg
SMTDRRI8D58	16	16		750	1.6kg	3	2.25k	9k	23.5kg
SMTDRS0628	12	8		2000	930g	5	10k	40k	23kg
SMTDRS0728	16	12		1000	750g	4	4k	16k	16kg
SMTDRS0730	16	12		1000	800g	4	4k	16k	17kg
SMTDRS0732	16	12		1000	850g	4	4k	16k	18kg
SMTDRS0745	16	12		1000	1.1kg	4	4k	16k	22kg
SMTDRS1045	24	16		750	1.7kg	3	2.25k	9k	25kg
SMTDRS1255	24	16		500	1.6kg	3	1.5k	6k	24kg
SMTDRS1265	24	16		500	1.8kg	3	1.5k	6k	26kg
SMTDRS1275	24	16		350	1.6kg	3	1.05k	4.2k	24kg
SMTER63	16	12		1000	1.4kg	3	3k	16k	21kg
SMTER64	16	12		1000	1.5kg	3	3k	16k	22kg
SMTER65	16	12		1000	1.6kg	3	3k	16k	23kg
SMTER134	24	16		500	2.2kg	2	1k	6k	31kg
SMTBW104	24	16		500	1.2kg	2	1k	6k	19kg
SMTBW105	24	16		500	1.3kg	2	1k	6k	20kg
SMTBW125	24	16		500	1.8kg	2	1k	6k	26kg
SMTBW134	24	16		500	1.9kg	2	1k	6k	27.5kg
SMTTC30	24	16		350	950g	3	1.05k	4.2k	16kg
SMTTC38	32	20		250	1.1kg	2	0.5k	2k	12kg
SMTTC44	32	20		250	1.3kg	2	0.5k	2k	14.9kg
SMTTC50	32	20		250	1.6kg	2	0.5k	2k	18kg
SMTLF632	24	16		500	1.2kg	3	1.5k	6k	18kg
SMB302540	12	8	500		0.32kg	4	2k	24k	20kg
SMB302585	16	8	500		0.78kg	4	2k	24k	42kg
SMBM5H	24	12		1000	1.3kg	3	3k	12k	18kg



Series	Tape size		Parts Per Reel			Per Box		Per Carton	
	W	P	7"	13"	G.W	N(卷數)	Q'ty	Q'ty	G.W
SNR2010PE	8	4	2000		195g	5	10k	40k	6.4kg
SNR2510PE	8	4	2000		220g	5	10k	40k	6.9kg
SNR2512PE	8	4	2000		230g	5	10k	40k	7.1kg
SNR3010PE	8	4	2000		230g	5	10k	40k	7.1kg
SNR3012PE	8	4	2000		240g	5	10k	40k	7.3kg
SNR3015PE	8	4	2000		250g	5	10k	40k	7.5kg
SNR4018E	8	4	800		350g	5	4k	16K	9.5kg
SNR5040E	12	8		1500	880g	4	6k	12k	9.6kg
SNR6020E	16	8		2000	960g	4	8k	16k	10.3kg
SNR6045E	16	12		1000	900g	3	3k	6k	8.2kg
SNR8040E	16	12		1000	1.2Kg	3	3k	6k	9.8kg
SMW 1608 LB	8	4	4000		122g	5	20k	80k	4.9kg
SMW 2012 LB	8	4	3000		136g	5	20k	80k	5.2kg
SMW 2016 LB	8	4	2000		150g	5	10k	40k	5.5kg
SMW 2518 LB	8	4	2000		164g	5	10k	40k	5.7kg
HPI201610(R)	8	4	3000		140g	5	15K	60k	5.3kg
HPI201612(R)	8	4	3000		152g	5	15K	60k	5.6kg
HPI252010(R)	8	4	3000		172g	5	15K	60k	6.0kg
HPI252012(R)	8	4	3000		190g	5	15K	60k	6.3kg
UPI (X)0412	12	8		4000	1.35kg	2	8K	32K	14.8kg
UPI (X)0402	12	8		2000	1.35kg	2	6K	24K	14.8kg
UPI (X)0512	16	12		3000	1.2kg	2	6K	24K	13.6kg
UPI (X)0515	16	12		2000	1.05kg	2	4K	16K	12.4kg
UPI (X)0502	16	12		2000	1.15kg	2	4K	16K	13.2kg
UPI (X)0503	16	12		1500	1.25kg	2	3K	12K	14.0kg
UPI (X)0612	16	12		3000	1.2kg	2	6k	24k	13.6kg
UPI (X)0615	16	12		2000	1.1kg	2	4k	16k	12.8kg
UPI (X)0618	16	12		2000	1.35kg	2	4k	16k	14.8kg
UPI (X)0603	16	12		1500	1.85kg	2	3k	12k	18.8kg
UPI (X)0604	16	12		1000	1.75kg	2	2k	8k	18.0kg
UPI (X)1004	24	16		900	2.57kg	2	1.8k	7.2k	24.5kg
UPI (X)1005	24	16		800	2.4 kg	2	1.6k	6.4k	23.2kg
UPI (X)1203	24	16		500	2.75kg	2	1.0k	4k	26.0kg
UPI (X)1205	24	16		500	2.82kg	2	1.0k	4k	26.5kg
UPI (X)1207	24	16		400	3.1kg	2	0.8k	3.2k	28.8kg
SMB-100505	8	2	10000		140g	5	50K	200k	5.3kg
SMB-160808	8	4	4000		146g	5	20K	80k	5.4kg
SMB-201209	8	4	4000		180g	5	20K	80k	6.1kg
SMC-100505E	8	2	10000		140g	5	50k	200k	5.3kg
SMC-160808E	8	4	4000		146g	5	20k	80k	5.4kg
SMC-201209E	8	4	4000		180g	5	20k	80k	6.1kg
SMI-160808E	8	4	4000		100g	5	20k	80k	4.5kg
SMI-201209E	8	4	4000		120g	5	20k	80k	4.7kg